

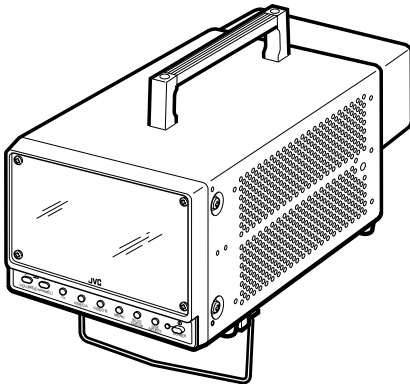

## LCCS VIDEO MONITOR

# TM-L450TU

## INSTRUCTIONS



### For Customer Use:

Enter below the Serial No. which is located on the bottom of the cabinet. Retain this information for future reference.

Model No. : TM-L450TU

Serial No. : \_\_\_\_\_

Contents	Page
<b>IMPORTANT SAFETY PRECAUTIONS</b>	<b>2</b>
<b>CONTROLS AND FEATURES</b>	<b>6</b>
FRONT & RIGHT VIEW	6
REAR VIEW	8
<b>BASIC CONNECTION EXAMPLES</b>	<b>9</b>
<b>PREPARING POWER SUPPLY</b>	<b>10</b>
INDOOR USAGE (AC Power Supply)	10
OUTDOOR USAGE (DC Power Supply)	11
<b>BASIC OPERATIONS</b>	<b>12</b>
MONITORING THE PICTURE	12
WATCHING TV	13
<b>SETTINGS AND ADJUSTMENTS</b>	<b>14</b>
BASIC MENU OPERATION	14
MENU CONTENTS	15
SCREEN SIZE ADJUSTMENTS	16
BLUE CHECK FUNCTION	16
SETTING TV CHANNELS	17
<b>TROUBLESHOOTING</b>	<b>18</b>
<b>CHARACTERISTICS OF LCCS VIDEO MONITOR SYSTEM</b>	<b>20</b>
<b>SPECIFICATIONS</b>	<b>21</b>

**Thank you for purchasing this JVC LCCS video monitor.**

Before using, read and follow all instructions carefully to take full advantage of the monitor's capabilities. Retain these instructions for future reference.

\* LCCS = Liquid Crystal Color Shutter

# IMPORTANT SAFETY PRECAUTIONS

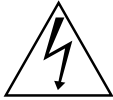

## CAUTION

**RISK OF ELECTRIC SHOCK  
DO NOT OPEN**



**CAUTION: To reduce the risk of electric shock,  
do not remove cover (or back).  
No user serviceable parts inside.  
Refer servicing to qualified service personnel.**



The lightning flash with arrowhead symbol, within an equilateral triangle, is intended to alert the user to the presence of uninsulated "dangerous voltage" within the product's enclosure that may be of sufficient magnitude to constitute a risk of electric shock to persons.



The exclamation point within an equilateral triangle is intended to alert the user to the presence of important operating and maintenance (servicing) instructions in the literature accompanying the appliance.

## **WARNING:**

**TO PREVENT FIRE OR SHOCK HAZARDS,  
DO NOT EXPOSE THIS APPLIANCE TO  
RAIN OR MOISTURE.**

## **CAUTION:**

**TO INSURE PERSONAL SAFETY,  
OBSERVE THE FOLLOWING RULES  
REGARDING THE USE OF THIS UNIT.**

1. Operate only from the power source specified on the unit.
2. Avoid damaging the AC plug and power cord.

3. Avoid improper installation and never position the unit where good ventilation is unattainable.
4. Do not allow objects or liquid into the cabinet openings.
5. In the event of trouble, unplug the unit and call a service technician. Do not attempt to repair it yourself or remove the cover.

Changes or modifications not approved by JVC could void the warranty.

\* When you don't use this Appliance for a long period of time, be sure to disconnect both the power plug from the AC outlet and antenna for your safety.

# IMPORTANT SAFEGUARDS

## CAUTION:

### Please read and retain for your safety.

Electrical energy can perform many useful functions. This Appliance has been engineered and manufactured to assure your personal safety. But improper use can result in potential electrical shock or fire hazards. In order not to defeat the safeguards incorporated in this Appliance, observe the following basic rules for its installation, use and servicing.

And also follow all warnings and instructions marked on your Appliance.

## INSTALLATION

- 1 Your Appliance is equipped with a grounding-type AC line plug (three-blade type), a plug having a third (grounding) pin.

(GROUNDING-TYPE)

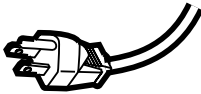

This plug will only fit into a grounding-type power outlet. This is a safety feature. Should you be unable to insert the plug into the outlet, contact your electrician to replace your outlet. Do not defeat the safety purpose of the grounding-type plug.

- 2 Operate the Appliance only from a power source as indicated on the Appliance or refer to the operating instructions for this information. If you are not sure of the type of power supply to your home, consult your Appliance dealer or local power company. For battery operation, refer to the operating instructions.

- 3 Overloaded AC outlets and extension cords are dangerous, and so are frayed power cords and broken plugs. They may result in a shock or fire hazard. Call your service technician for replacement.
- 4 Do not allow anything to rest on or roll over the power cord, and do not place the Appliance where power cord is subject to traffic or abuse. This may result in a shock or fire hazard.
- 5 Do not use this Appliance near water — for example, near a bathtub, washbowl, kitchen sink, or laundry tub, in a wet basement, or near swimming pool, etc.
- 6 If an outside antenna is connected to the Appliance, be sure the antenna system is grounded so as to provide some protection against voltage surges and built-up static charges. Section 810 of the National Electrical Code provides information with respect to proper grounding of the mast and supporting structure, grounding of the lead-in wire to an antenna discharge unit, size of grounding conductors, location of antenna discharge unit, connection requirements for the grounding electrode.

(continued on the next page)

- 7 An outside antenna system should not be located in the vicinity of overhead power lines or other electric light or power circuits, or where it can fall into such power lines or circuits. When installing an outside antenna system, extreme care should be taken to keep from touching such power lines or circuits as contact with them might be fatal.

**EXAMPLE OF ANTENNA GROUNDING AS PER NATIONAL ELECTRICAL CODE**

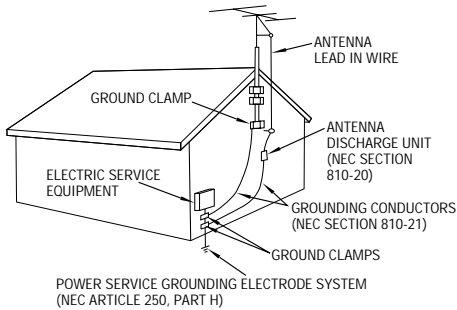

**NEC – NATIONAL ELECTRICAL CODE**

- 8 Appliances are provided with ventilation openings in the cabinet to allow heat generated during operation to be released.

Therefore:

- Never block the bottom ventilation slots of a portable Appliance by placing it on a bed, sofa, rug, etc.
- Never place an Appliance in a “built-in” enclosure unless proper ventilation is provided.
- Never cover the openings with a cloth or other material.
- Never place the Appliance near or over a radiator or heat register.

- 9 To avoid personal injury:

- Do not place an Appliance on a sloping shelf unless properly secured.
- Use only a cart or stand recommended by the Appliance manufacturer.
- Do not try to roll a cart with small casters across thresholds or deep pile carpets.
- Wall or shelf mounting should follow the manufacturer’s instructions, and should use a mounting kit approved by the manufacturer.

**USE**

- 10 Caution children about dropping or pushing objects into the Appliance through cabinet openings. Some internal parts carry hazardous voltages and contact can result in a fire or electrical shock.

- 11 Unplug the Appliance from the wall outlet before cleaning. Do not use liquid or an aerosol cleaner.

- 12 Never add accessories to an Appliance that has not been designed for this purpose. Such additions may result in a hazard.

- 13 For added protection of the Appliance during a lightning storm or when the Appliance is to be left unattended for an extended period of time, unplug it from the wall outlet and disconnect the antenna. This will prevent damage to product due to lightning storms or power line surges.

- 14** An Appliance and cart combination should be moved with care. Quick stops, excessive force, and uneven surfaces may cause the Appliance and cart combination to overturn.



## SERVICE

- 15** Unplug this Appliance from the wall outlet and refer servicing to qualified service personnel under the following conditions:
- A. When the power cord or plug is damaged or frayed.
  - B. If liquid has been spilled into the Appliance.
  - C. If the Appliance has been exposed to rain or water.
  - D. If the Appliance does not operate normally by following the operating instructions. Adjust only those controls that are covered in the operating instructions as improper adjustment of other controls may result in damage and will often require extensive work by a qualified technician to restore the Appliance to normal operation.
  - E. If the Appliance has been dropped or damaged in any way.
  - F. When the Appliance exhibits a distinct change in performance — this indicates a need for service.
- 16** Do not attempt to service this Appliance yourself as opening or removing covers may expose you to dangerous voltage or other hazards. Refer all servicing to qualified service personnel.
- 17** When replacement parts are required, have the service technician verify in writing that the replacement parts he uses have the same safety characteristics as the original parts. Use of manufacturer's specified replacement parts can prevent fire, shock, or other hazards.
- 18** Upon completion of any service or repairs to this Appliance, please ask the service technician to perform the safety check described in the manufacturer's service literature.
- 19** When an Appliance reaches the end of its useful life, improper disposal could result in a picture tube implosion. Ask a qualified service technician to dispose of the Appliance.
- 20** Note to CATV system installer.  
This reminder is provided to call the CATV system installer's attention to Article 820-40 of the NEC that provides guidelines for proper grounding and, in particular, specifies that the cable ground shall be connected to the grounding system of the building, as close to the point of cable entry as practical.

---

## SCREEN BURN

- Try to avoid displaying still images or extremely bright images on the screen for an extended period of time. If left on screen for too long the image will be permanently etched onto the CRT — a phenomenon known as “screen burn”. Screen burn is not a problem when displaying moving pictures during video playback.

# CONTROLS AND FEATURES

## PRODUCT: FRONT & RIGHT VIEW

### FRONT VIEW

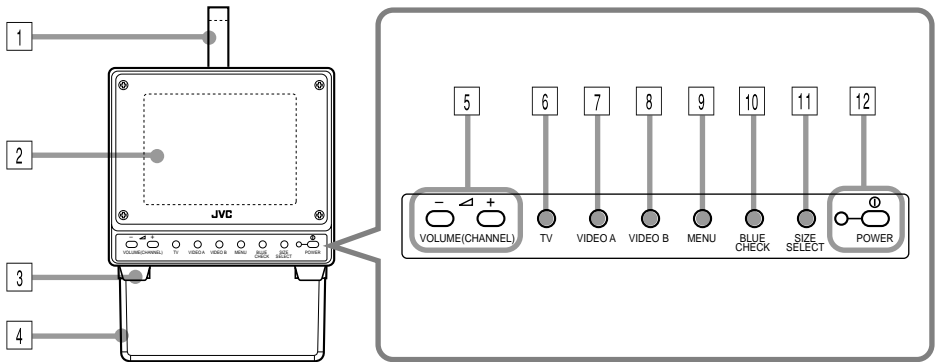

### RIGHT VIEW

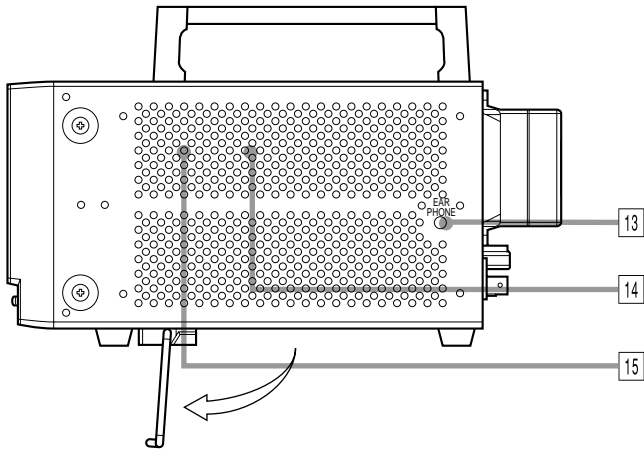

---

## FRONT VIEW

- 1 Carrying Handle**

Used to carry the monitor.  
Can be removed when the monitor is mounted in a rack.
- 2 Screen**

A removable shield protecting the liquid crystal shutter is provided.
- 3 Feet**

Can be removed when the monitor is mounted in a rack.
- 4 Stand**

The monitor will be tilted about 18° when the stand is pulled out.  
Can be removed when the monitor is mounted in a rack.  
\* DO NOT push down on the monitor from above or place heavy objects on it when the stand is pulled out.
- 5 VOLUME (CHANNEL) –/+ Buttons**
  - Usually used as VOLUME (CHANNEL) –/+ buttons to adjust the volume.
  - For about 8 seconds after the TV button is pressed (while the TV button is blinking in green), they act as VOLUME (CHANNEL) –/+ buttons for changing TV channels.
- 6 TV Button**

Press this button to watch TV.  
The button blinks in green when it is pressed. While it is blinking, you can change channels with the VOLUME (CHANNEL) –/+ buttons. If you want to adjust the volume while the TV button is blinking, press the TV button again so that the button lights in green, then adjust the volume with the VOLUME (CHANNEL) –/+ buttons.  
The TV button lights in green when TV is selected.
- 7 VIDEO A Button**

Press this button to select the video signal input to the VIDEO A terminal and the audio signal input to the AUDIO IN A terminal.  
The button lights in green when VIDEO A is selected.
- 8 VIDEO B Button**

Press this button to select the video signal input to the VIDEO B terminal and the audio signal input to the AUDIO IN B terminal.  
The button lights in green when VIDEO B is selected.

- 9 MENU Button**

Press this button to access the menu for performing settings and adjustments on the monitor.  
The selected item displayed on the menu changes each time this button is pressed.
- 10 BLUE CHECK Button**

Press this button to use the blue check function.  
The blue check function helps make the CHROMA and PHASE settings more accurate.
- 11 SIZE SELECT Button**

Press this button to change the screen size. The screen size changes each time this button is pressed.
- 12 POWER Switch/Indicator**

Press this switch to turn the power ON or OFF. The POWER indicator lights in green when the power is ON.

---

## RIGHT VIEW

- 13 Earphone Terminal**

Stereo minijack output terminal.  
(Actual output is monaural.)
- 14 Built-in Speaker**

A built-in speaker is located in the right panel when the monitor is viewed from the front. (When earphones are connected to the earphone terminal, no sound is output from the speaker.)
- 15 Intake Fan**

DO NOT cover the intake fan or ventilation slot as this could cause the monitor to overheat, resulting in a fire or malfunction.

# CONTROLS AND FEATURES (cont'd)

## PRODUCT: REAR VIEW

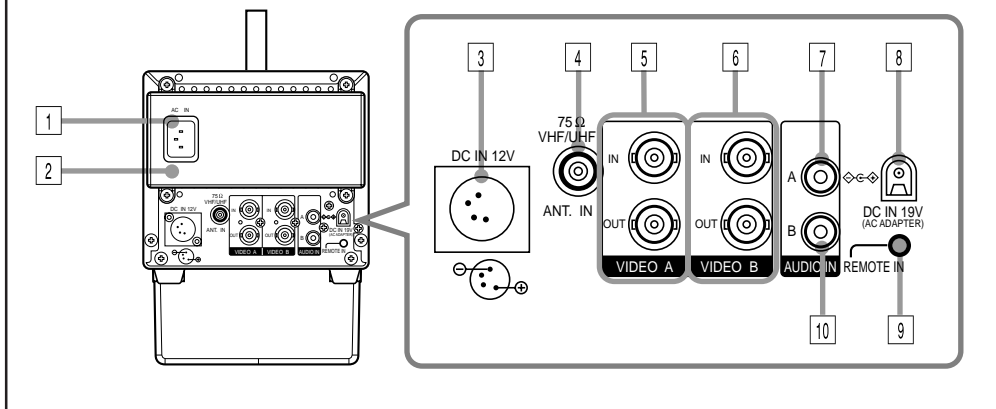

### 1 AC IN (AC Power Input) Terminal

Power input terminal.  
Connect the provided power cord to the terminal.

### 2 AC Adapter

Can be removed when a commercial DC power supply (DC 12 V) is used.

### 3 DC IN 12 V (DC Power Input) Terminal

Connect a commercial DC power supply. (Consult your dealer for usable DC power supplies.)

### 4 75 Ω VHF/UHF (TV Antenna) Terminal

Connect the TV antenna cable to watch TV.

### 5 VIDEO A Terminals

BNC video signal input (IN) and output (OUT) terminals. The output terminal is bridge-connected (auto termination).

**IN** : Connect to the composite video signal output terminal of a video camera, etc.

**OUT** : Connect to the composite video signal input terminal of a VCR, etc.

### 6 VIDEO B Terminals

BNC video signal input (IN) and output (OUT) terminals. The output terminal is bridge-connected (auto termination).

**IN** : Connect to the composite video signal output terminal of a video camera, etc.

**OUT** : Connect to the composite video signal input terminal of a VCR, etc.

### 7 AUDIO IN A Terminal

RCA-pin monaural audio signal input terminal. Connect it to the audio signal output terminal of the video camera, etc. connected to the VIDEO A input (IN) terminal.

### 8 DC IN 19 V Terminal (Exclusively for Provided AC Adapter)

Connect the provided AC adapter to this terminal.

\* DO NOT use any AC adapter other than the one provided.

### 9 REMOTE IN (Remote Control Input) Terminal

Mini-jack input terminal.

A wired remote control can be connected to this terminal.  
(Consult your dealer for details.)

### 10 AUDIO IN B Terminal

RCA-pin monaural audio signal input terminal. Connect it to the audio signal output terminal of the video camera, etc. connected to the VIDEO B input (IN) terminal.



# BASIC CONNECTION EXAMPLES

- Before connecting your system, make sure that all units are turned off.
- If you are not connecting any equipment to one of the bridged video output (VIDEO OUT) terminals, be sure NOT to connect any cables to the terminal as this will cause the terminating resistance switch to open (auto terminate function).
- DO NOT connect a piece of equipment to the same pair of video input (VIDEO IN) and video output (VIDEO OUT) terminals.
- Also refer to the instructions of the equipment being connected.

→ : VIDEO A Connection Example

---→ : VIDEO B Connection Example

↘ : Signal Flow

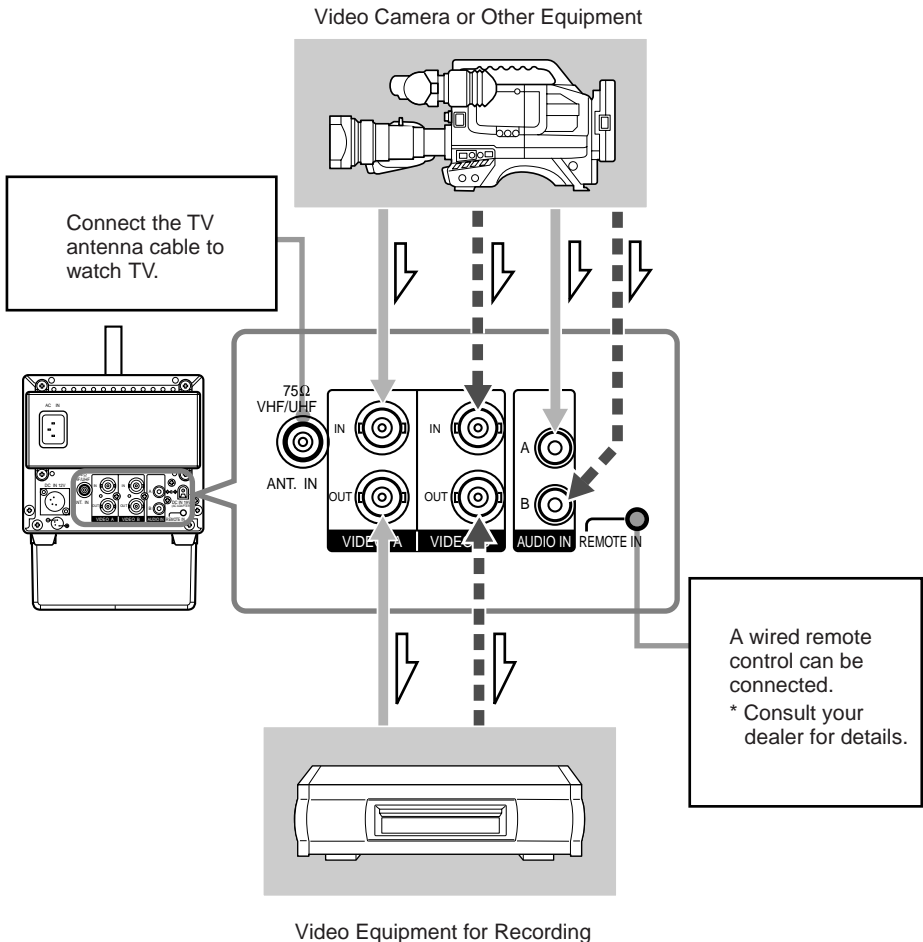

# PREPARING THE POWER SUPPLY

## Precautions

Use one of the following power supplies:

- AC power supply (120 V AC, 60 Hz): Use the provided power cord.
- DC power supply (12 V DC): Use any brand of external DC battery pack (commercial) or other DC power supply.

## INDOOR USAGE (AC Power Supply)

Connect the provided power cord to the AC IN (AC power input) terminal and an AC outlet.

- When AC power supply is used, the power from the DC IN 12 V (DC power input) terminal is automatically cut off.

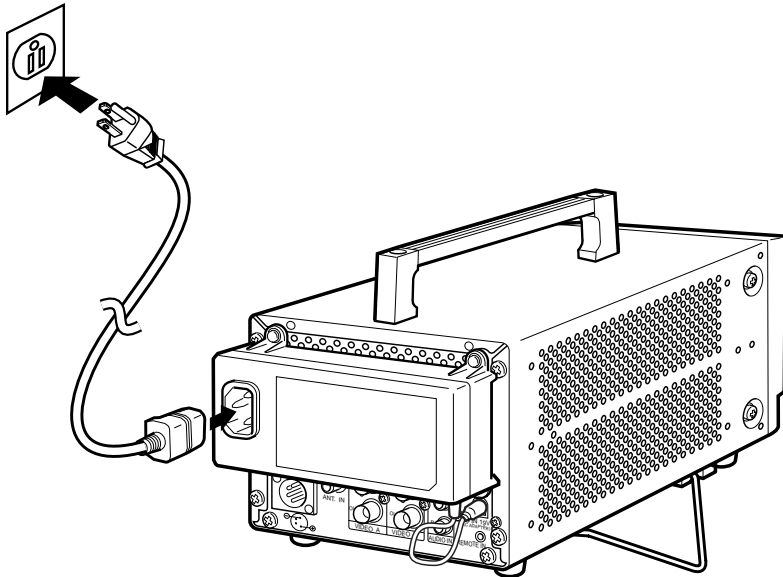

### Note:

- Do not use any AC adapter other than the one provided (model: ADP-50VB REV. D), otherwise it may cause a malfunction.

## Using Outside North America

A different AC power cord will be required.

- The AC power cord provided with this monitor can only be used with AC 120 V, 50 Hz/60 Hz (North America). To use this monitor outside North America, you will need to get a different AC power cord that matches the voltage and/or power plug used in that country.

## OUTDOOR USAGE (DC Power Supply)

Connect any commercial brand of external DC battery pack or other DC power supply to DC IN 12 V (DC power input) terminal with the exclusive power cord.

### Connection example: using an external DC battery pack

Before performing the following, be sure to unplug the power cord.

The DC battery pack fits into the attachment holes on the back of the monitor.

- The screw holes for fixing the DC battery are M4 size and have a depth of 12 mm. The fixing screws must be less than 12 mm long.

### 1 Remove the AC Adapter.

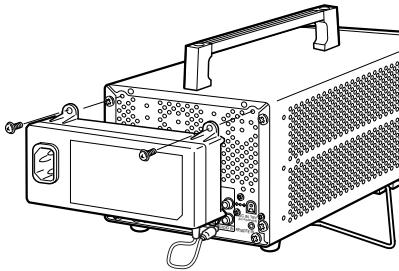

### 2 Attach the DC Battery Pack.

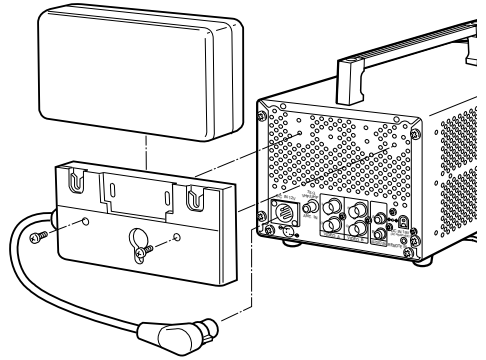

#### Notes:

- Do not leave the monitor connected to a battery via the DC IN 12 V (DC power input) terminal for long periods when the monitor is not in use.  
A slight electrical current is passed to the battery protection circuit even when the power is turned off, which consumes battery power.
- Consult your dealer for usable DC 12 V power supplies.
- Anton Bauer, PAG or other commercial brand of external DC battery pack can be used.
- Consult your dealer for details.

#### ■ Electrical Polarity of DC IN 12 V (DC Power Input) Terminal

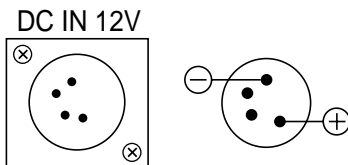

#### ■ Electrical Polarity of DC IN 19 V (Exclusively for AC Adapter Input) Terminal

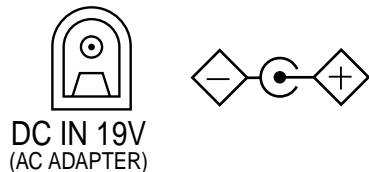

# BASIC OPERATIONS

## MONITORING THE PICTURE

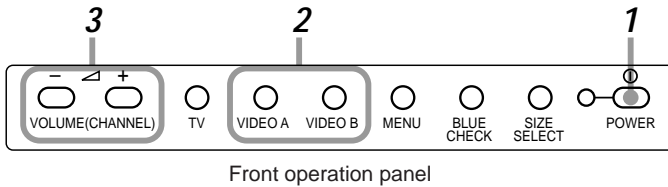

### Precautions

- Connect video components properly to the connection terminals on the rear of the monitor. (See pages 8 and 9)

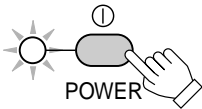

### 1 Press the power button to turn the power ON.

The power indicator lights in green.

- To turn the power OFF, press the power button again.

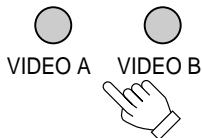

### 2 Select a video input with the VIDEO A or VIDEO B button.

The button pressed lights in green.

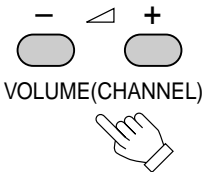

### 3 Adjust the volume with the VOLUME (CHANNEL) -/+ buttons.

Screen indication

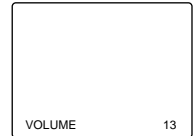

### POWER Indicator

The status of the POWER indicator varies depending on the following conditions:

Unlit	Power OFF
Lights in green	Power ON, usual operation
Lights in orange *1	Low voltage from DC power supply (battery, etc.)
Lights in red *1	Battery protection circuit active
Blinks in green	Power save function active

\*1: The color of the POWER indicator does not show the exact status of the battery. Depending on the battery type, the power may be cut off even before the POWER indicator lights in orange/red. This is due to characteristics of the battery or the operation of the battery protection circuit, and is not a malfunction. If this occurs, recharge the battery.

### Screen Indication

The screen indication disappears about 8 seconds after button operation.

### Unsuitable Environments for Viewing

- Watching the monitor in a room that is too dark can damage your eyes. Keep the room properly lit. Watching the monitor for long periods can also damage your eyes. Be sure to take occasional breaks.
- The picture may appear distorted depending on the environment around the monitor. If it does, DO NOT use the monitor as it could damage your eyes.

## WATCHING TV

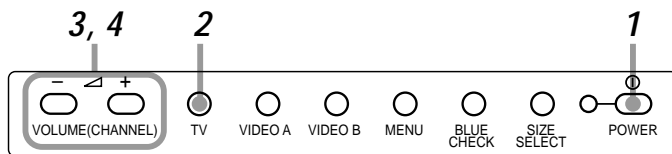

Front operation panel

### Precautions

- Connect the TV antenna cable. (☞ page 9)
- Set TV channels. (☞ pages 14, 15 and 17)

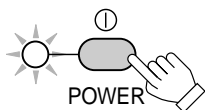

### 1 Press the power button to turn the power ON.

The power indicator lights in green.

- To turn the power OFF, press the power button again.



### 2 Press the TV button to select TV.

The TV button blinks in green for about 8 seconds.

(After 8 seconds, the TV button lights in green.)

Screen indication

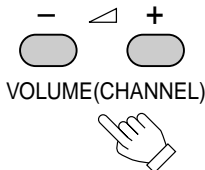
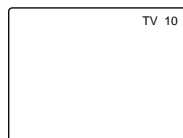

### 3 While the TV button is blinking in green, select the TV station (channel) you want to watch.

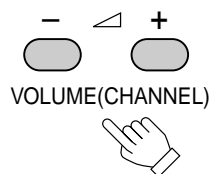
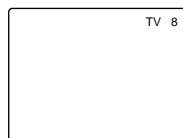

### 4 After the TV button finishes blinking and lights in green, adjust the volume with the VOLUME (CHANNEL) -/+ buttons.

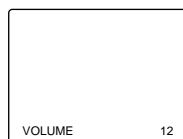

#### If you want to adjust the volume immediately after selecting TV:

Press the TV button again. The button stop blinking and then lights in green. After that, you can adjust the volume with the VOLUME (CHANNEL) -/+ buttons.

#### If you want to change the TV channel during TV reception:

Press the TV button. While the TV button is blinking, press the VOLUME (CHANNEL) -/+ buttons. (+: higher/-: lower)

# SETTINGS AND ADJUSTMENTS

## BASIC MENU OPERATION

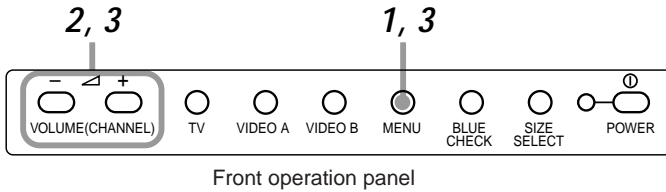

### 1 Press the MENU button to select the desired item to adjust (set).

The selected item changes each time the MENU button is pressed. The currently selected item is displayed on the monitor.

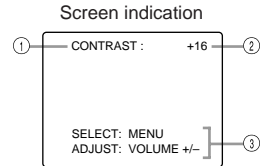

#### Screen Indications

- ① Item
- ② Adjusting (setting) value
- ③ Help indication

CONTRAST → BRIGHTNESS → SHARPNESS → CHROMA →  
PHASE → COLOR SYSTEM → POWER SAVE → COLOR SW →  
CH STATUS → CH SEARCH START → CH SKIP ON →  
CH RESET ON → .....

\* Some items may not be displayed depending on which input mode is selected. Items that are not displayed cannot be adjusted (set).

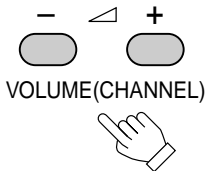

### 2 Adjust (set) the item selected in procedure 1 with the VOLUME (CHANNEL) +/- buttons.

\* When adjusting, the help indicator disappears. It is displayed again 2 seconds after adjustment is complete.

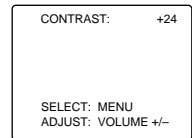

### 3 Repeat procedures 1 and 2 to adjust (set) more items.

\* Refer to MENU CONTENTS on the next page for the name of each item.

## MENU CONTENTS

You can adjust (set) the following items on the menu screen. Each adjusted (set) value is automatically memorized.

The values inside [ ] are the factory presets.

### 1 CONTRAST (Picture Contrast)

Adjusts the picture contrast. Decreasing the value lowers the contrast, and increasing the value raises it.

Adjustable range: -30 to +30 [0]

### 2 BRIGHTNESS (Picture Brightness)

Adjusts the picture brightness. Decreasing the value makes the picture darker, and increasing the value makes it brighter.

Adjustable range: -30 to +30 [0]

### 3 SHARPNESS (Picture Sharpness)

Adjusts the picture sharpness. Decreasing the value makes the picture softer, and increasing the value makes it more sharp.

Adjustable range: -30 to +30 [0]

### 4 CHROMA (Picture Chroma)

Adjusts the picture chroma. Decreasing the value makes the picture lighter, and increasing the value makes it deeper.

Adjustable range: -30 to +30 [0]

### 5 PHASE (Picture Phase)

Adjusts the picture phase. Decreasing the value makes the picture more reddish, and increasing the value makes it more greenish.

Adjustable range: -30 to +30 [0]

\* PHASE can be adjusted only with NTSC video signals.

\* PHASE is not displayed when PAL is selected.

### 6 COLOR SYSTEM (Color System)

Displays the color system (NTSC or PAL) used by the video equipment.

\* COLOR SYSTEM is not displayed when TV is selected.

### 7 POWER SAVE (Power Save)

With the power save function set to ON (active), the monitor automatically enters standby mode when no video signal is input. When the power save function is active, the POWER indicator blinks in green. When a video signal is input, the power save function becomes inactive and the monitor is restored to normal operation.

Pressing any buttons on the front operation panel also sets the power save function to inactive. [OFF]

\* The power save function becomes active when no video signal is input for over 30 seconds.

### 8 COLOR SW

Turns the picture into black and white for checking the white balance. [ON]

**The following items are displayed only when TV is selected:**

### 9 CH STATUS (Channel Status)

With CH STATUS set to OFF (inactive), the TV channel is not displayed when it is selected. [ON]

### 10 CH SEARCH START (Initiate Channel Search)

The monitor automatically searches for broadcast stations (VHF/UHF) it can receive and memorizes them. (Also refer to SETTING TV CHANNELS on page 17.)

\* The monitor memorizes channels in ascending order.

\* When you move the monitor into an area that receives different channels, perform CH SEARCH START again.

### 11 CH SKIP ON (Channel Skip ON)

Deletes a channel set in CH SEARCH [10]. Select the channel to be deleted and perform CH SKIP ON.

### 12 CH RESET ON (Channel Reset ON)

Resets all TV channels set in [10] CH SEARCH START to their factory presets. After performing channel reset, all TV channels (VHF: 2 - 13 / UHF: 14 - 69) can be tuned.

# SETTINGS AND ADJUSTMENTS (cont'd)

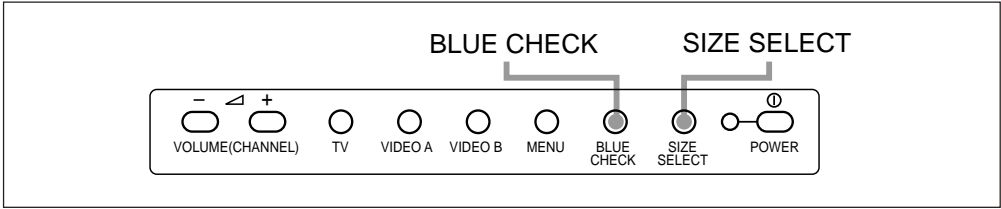

## SCREEN SIZE ADJUSTMENTS

Adjust the screen size to get the desired picture.



**Press the SIZE SELECT button.**

The screen size changes in the following order each time the SIZE SELECT button is pressed.

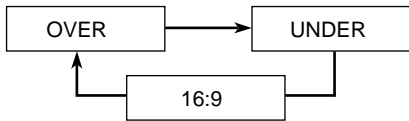

**OVER** suitable for monitoring a picture with a normal aspect ratio of 4:3

**UNDER** can monitor an entire picture with a normal aspect ratio of 4:3 by reducing its size

**16:9** suitable for monitoring a picture with an aspect ratio of 16:9

### When using the screen mode adjustment function:

- This monitor has a screen mode adjustment (SIZE SELECT) function. When a screen mode is selected that does not match the aspect ratio of the TV program or other video source you want to watch, the picture may appear different from the original.
- If you place this monitor in a public space (e.g. coffee shop, hotel lobby, etc.) for commercial purposes or for public exhibition, and if you use a screen mode adjustment (SIZE SELECT) function on the video image, it may be a violation of copyright law.

## BLUE CHECK FUNCTION

The blue check function cuts the red and green signal and displays only the blue signal.

The blue check function enables you to adjust CHROMA (picture chroma) or PHASE (picture phase) easily.

\* PHASE can only be adjusted with NTSC video signals.

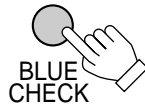

**Press the BLUE CHECK button.**

The blue check function switches ON (active) or OFF (inactive) each time the BLUE CHECK button is pressed.

### Adjusting CHROMA (picture chroma) or PHASE (picture phase) with the blue check function:

- 1 Input a standard color bar (NTSC or PAL) signal to the VIDEO A IN or VIDEO B IN terminal at the rear of the monitor.
- 2 Press the VIDEO A or VIDEO B button to display the standard color bars.
- 3 Press the BLUE CHECK button to turn the blue check function ON (active).

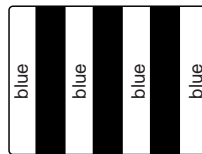

(continued on the next page)



- 4 Adjust CHROMA (picture chroma) or PHASE (picture phase).

**When an NTSC color bar signal is input:**

- ① Adjust CHROMA (picture chroma) so that the blue bars on the left and right side of the screen have the same brightness.
- ② Adjust PHASE so that the two blue bars at the center of the screen have the same brightness.
- ③ Repeat procedure 1 and 2 so that all four blue bars on the screen have the same brightness.

**When a PAL color bar signal is input:**

Adjust CHROMA (picture chroma) so that the blue bars on the left and right side of the screen have the same brightness.

\* Refer to BASIC MENU OPERATION on page 14 for the adjustment procedure.

- 5 After adjustment is complete, press the BLUE CHECK button again to turn the blue check function OFF (inactive).

## SETTING TV CHANNELS

This monitor is factory-preset to tune all VHF (2 to 13) and UHF (14 to 69) TV channels.

- To perform the following, press the TV button to select TV.

When you want to reset the memorized TV channels, perform CH SEARCH START (initiate channel search) from the menu screen (refer to pages 14 and 15). The monitor automatically searches for broadcasting stations (VHF/UHF) and memorizes them.

You can also delete channels you do not want to watch. Select the channel to be deleted and perform CH SKIP ON (channel skip ON) from the menu screen (refer to pages 14 and 15).

\* Channels deleted by CH SKIP ON (channel skip ON) cannot be tuned again. If you want to tune them, perform CH RESET ON (channel reset ON) from the menu screen to tune all VHF (2 to 13) and UHF (14 to 69) TV channels.

\* In areas where the radio wave reception weak, searching for TV channels will not function well. In this case, perform CH RESET ON (channel reset ON) from the menu screen to tune all VHF (2 to 13) and UHF (14 to 69) TV channels.

# TROUBLESHOOTING

Before requesting repair, check the following points.

Problems	Points to be checked	Measures (remedy)
<b>No power supply.</b>	Is the power plug loosened or disconnected?	Firmly insert the power plug.
	Is the battery charged properly? (when a DC power supply is used)	Charge the battery or replace the charged battery (refer to the battery charger you are using).
<b>No picture with the power on.</b>	Is the signal output from the connected equipment?	Set the connected equipment correctly.
	Is the input signal selected correctly?	Select the correct input.
	Is the video signal cable disconnected?	Connect the video signal cable firmly.
<b>No sound.</b>	Is the audio signal output from the connected equipment?	Set the connected equipment correctly.
	Is the volume set to minimum?	Adjust the volume properly.
	Is the audio signal cable disconnected?	Connect the audio signal cable firmly.
<b>Picture is shaking.</b>	Is the monitor close to a motor, transformer or other device generating a strong magnetic field?	Move the monitor away from the device until the picture stops shaking.
<b>No colors, wrong colors, or dark picture.</b>	Has COLOR SW been set to OFF?	Set COLOR SW to ON in the menu.
	Has the picture control setting (CONTRAST, BRIGHTNESS, CHROMA or PHASE) been changed?	Adjust each setting to the standard value [0].
<b>Some parts of the picture are distorted.</b>	Is the monitor close to a speaker or magnet? Did you move a speaker or magnet close to the monitor?	Keep speakers and magnets away from the monitor.
<b>There are black parts on the top and bottom of the screen, and both horizontal sides of the picture is indented.</b>	Is the screen size set to 16:9?	Set the screen size to OVER or UNDER.

(continued on the next page)

<b>Problems</b>	<b>Points to be checked</b>	<b>Measures (remedy)</b>
<b>The screen size is small.</b>	Is the screen size set to UNDER?	Set the screen size to OVER.
<b>There is no TV reception.</b>	Is an antenna connected to the monitor?	Connect the TV antenna cable.
	Was the monitor moved to an area that receives different channels after CH SEARCH START (initiate channel search) was performed?	Perform CH SEARCH START each time the monitor is moved to an area that receives different channels so that the monitor can memorize the new broadcast stations. Otherwise, perform CH RESET ON (channel reset ON) to tune all TV channels.

**There may not be a solution to the following problems, although adjusting the antenna or taking measures against interfering equipment may improve the situation somewhat.**

**The screen appears snowy and noise is heard. (Snow)**

- Is the antenna connected properly?
- Has the antenna cable been cut or loosened?
- Has the antenna orientation been changed or is the antenna broken?

**The image is displayed two or three times on the monitor. (Ghosting)**

- This may be caused by mountains or buildings. Also, if the broadcast antenna is located nearby, the TV transmission the monitor receives directly from it may affect the picture.

**Spots are displayed and noise is heard. (Interference)**

- This may be caused by interfering radio waves generated by dryers, automobiles, motorcycles or fluorescent lights.

**Stripes are displayed and noise is heard. (Radio Interference)**

- This may be caused by radio interference generated by radio stations, personal computers, AV equipment or microwave ovens.

**The following are not malfunctions:**

- The monitor emits a strange sound when the room temperature changes suddenly. This is only a problem if an abnormality appears on the screen as well.
- If two or more monitors are operated next to each other, their images may shake or be distorted. This phenomenon is due to mutual interference; it is not a malfunction. Move the monitors away from each other until the interference disappears or turn the power off on any monitor that is not being used.
- If a magnet or speaker is placed close to the monitor, the picture may shake. This is caused by the magnetic effect and is not a malfunction.
- When the monitor is turned ON, the sound of a running motor may be heard. This is the cooling fan and is not a malfunction.
- When playing back a video tape, the upper edge of the picture may be distorted. This is caused by skew distortion and is not a malfunction.
- Vertical stripes may occur on a dark picture. This is caused by quantization noise (noise which occurs when a picture is digitized) and is not a malfunction.

# CHARACTERISTICS OF LCCS VIDEO MONITOR SYSTEM

---

## ■ PRINCIPLE BEHIND LCCS VIDEO MONITOR OPERATION

The LCCS Video Monitor is a combination of a black-and-white cathode-ray tube and liquid crystal color shutter (LCCS), which are used together to reproduce color images.

The video signal input to the monitor is demodulated into RGB primary color signals which are then stored in the field memory. Signals in the field memory are read three times faster than the input video signal is, and are displayed on the black-and-white cathode-ray tube in the order of R, G and B. (Three images are displayed during one field.)

Color filters on the liquid crystal color shutter change according to the displayed primary color signal, transforming the black-and-white images into R, G and B primary color images.

Because of the phenomenon known as persistence of vision, the R, G and B primary color images appear as a single color image to the human eye.

---

## ■ FEATURES OF LCCS VIDEO MONITOR

### • High Contrast

Thanks to its low permeability, the liquid crystal color shutter (LCCS) does not reflect outside light as much, enabling it to reproduce high-contrast images even in direct sunlight.

### • High Resolution

The use of a black-and-white cathode-ray tube (which has no picture elements) and a liquid crystal color shutter (LCCS) allows it to display images at high resolution.

### • No Irregular Color Caused By Magnetic Interference

Unlike with color cathode-ray tubes, irregular color does not occur on the display because the monitor does not have any color elements.

### • No Moire Patterns

Horizontal moire patterns (interference fringes) do not occur because the monitor does not have any color elements.

---

## ■ THE FOLLOWING ARE NOT MALFUNCTIONS:

- Picture hue changes depending on the angle from which the monitor is viewed.  
This is due to normal characteristics of the liquid crystal color shutter.
- Two horizontal stripes are displayed on the picture.  
This is due to the structure of the liquid crystal color shutter.
- Simple color image is displayed for an instant.  
This is due to normal characteristics of the LCCS video monitor.
- Patterns such as spots are displayed when the monitor is turned ON or OFF.  
This is due to normal characteristics of the liquid crystal color shutter.
- The color of characters or images seem to be shifted.  
This is due to normal characteristic of the LCCS video monitor.  
When images combined with a Macrovision copy protection signal or jittery images from a VCR, etc. are displayed on the monitor, their color may appear to be shifted.

# SPECIFICATIONS

<b>Type</b>	: LCCS video monitor
<b>Color System</b>	: NTSC/PAL
<b>RF Reception Channels</b>	: U.S.A. VHF: 2 – 13, UHF: 14 – 69
<b>Picture Tube</b>	: 4.5" measured diagonally, black and white
<b>Effective Screen Size</b>	: Width : 3-3/4" (94.2 mm) Height : 2-13/16" (70.7 mm) Diagonal : 4-1/2" (114.3 mm)
<b>Video Inputs</b>	: 2 line inputs, composite video, BNC connector x 4, 1 V(p-p), 75 $\Omega$ Bridge connection possible, 75 $\Omega$ auto termination
<b>Audio Inputs</b>	: 2 line inputs, monaural, RCA-pin connector x 2, 0.5 V (rms) high-impedance
<b>REMOTE IN Input</b>	: 1 line input, minijack connector
<b>Built-in Speaker</b>	: 2" (5 cm) round x 1, 0.2 W output
<b>Antenna Terminals</b>	: VHF/UHF compatible, 75 $\Omega$ , F connector
<b>Environmental Conditions</b>	: Operating temperature: 0°C – 40°C (32°F – 104°F) Operating humidity: 20% – 80% (non-condensing)
<b>Power Requirements</b>	: 100 V AC – 240 V AC 50 Hz/60 Hz or 12 V DC
<b>Power Consumption</b>	: 2 A (DC 19 V) (using an AC adapter) 3.8 A (DC 12 V) (using a battery)
<b>Weight</b>	: 8.0 lbs. (3.6 kg) (including AC adapter) 7.3 lbs. (3.3 kg) (not including AC adapter)
<b>Dimensions (W x H x D)</b>	: 5-3/4" x 7-1/4" x 11-1/2" (146 mm x 181.3 mm x 291.8 mm) * Including AC adapter, carrying handle, feet and stand (stored) (power cord not included)
<b>Provided Accessories</b>	: AC power cord [5.91 ft (1.8 m)] x 1 AC adapter [model: ADP-50VB REV. D] (attached to monitor) x 1

## Notes about Magnets

- DO NOT place the following close to the monitor: magnets, speakers, electric clocks, devices or toys which use a magnet, medical devices which use a magnet, or any other products which generate a magnetic field. Doing so may cause the picture to be distorted by their magnetic effect. Also, DO NOT place the monitor close to a high-voltage power line or transformer.
- If an external speaker is placed close to the monitor, the picture may be distorted. In this case, use a shielded speaker.

\* Dimensions and weight are approximate.

\* E. & O.E. Design and specifications are subject to change without notice.

\* Illustrations used in this manual have been exaggerated, abbreviated or compounded for explanatory purposes only. The appearance of the actual product may differ slightly.

# SPECIFICATIONS (cont'd)

## ■ Dimensions

Unit : inch (mm)

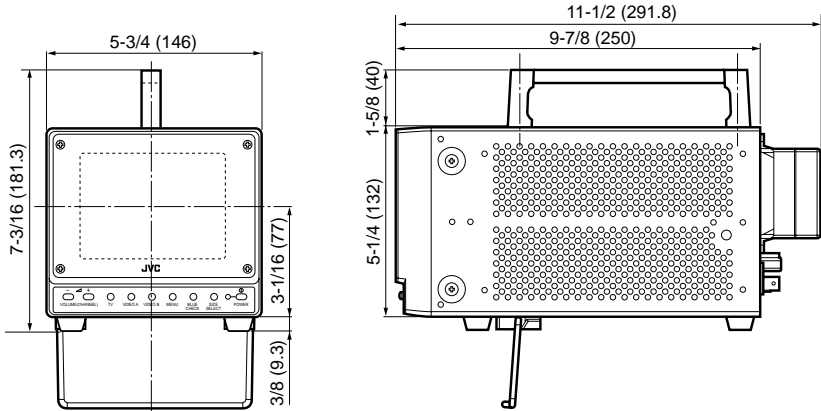



---

**JVC**®

**JVC PROFESSIONAL PRODUCTS COMPANY**

DIVISION OF US JVC CORP.

1700 Vallery Road Wayne, NJ07470

**JVC CANADA INC.**

21 Finchdene Square, Scarborough Ontario M1X 1A7

